

**ASILKOM** <sup>®</sup>  
Kompressor

**MASCHINEN, HERSTELLUNG, HANDEL**

Als Asilkom Kompresör Makina San. Ve Tic. Ltd. Şti produzieren wir seit 1995 Druckluftmaschinen, Lufttrockner, Aktivkohle-, Chemie- und Druckluftbehälter. Mit unserer jungen, dynamischen und unternehmerischen Identität haben wir uns in der kurzen Zeit bisher ein solides Image und Vertrauen bei unseren Verbrauchern geschaffen, was unser Konkurrenten in 50 Jahren erreicht hatten. Als Asilkom Kompresör gewähren wir für jedes von uns verkaufte Produkt eine 2-Jahres-Garantie und bieten technischen Support mit unseren 64 Servicezentren in der ganzen Türkei. Darüber hinaus sind wir als einer der weltweit führenden und etabliertesten Druckluftsystemanbieter in 17 Ländern tätig. Für jedes Produkt auf dem Markt erbringen wir Serviceleistungen außerhalb des Garantiebereichs. Jedes in unserer Einrichtung hergestellte Produkt wurde in Übereinstimmung mit internationalen Qualitätsstandards hergestellt und das CE-Zertifikat wurde registriert. Unser Unternehmen verfügt über eine Massenproduktionskapazität von über 5500 m<sup>2</sup>, davon 3000 m<sup>2</sup> geschlossene und 2500 m<sup>2</sup> offene Fläche. Dank unserer erfahrenen Mitarbeiter, unserer bundesweiten Händler, Dienstleistungen und dem Vertrauen unserer geschätzten Kunden sind Asilkom-Produkte mit ihrer Qualität zu einem der Vorreiter geworden. Mit diesem Verantwortungsbewusstsein bieten wir Ihnen gerne unsere Produkte an, die stets innovativen, effizienten Technologien folgen und bei der Qualität keine Kompromisse eingehen.

**ASILKOM** <sup>®</sup>  
Kompressor

**MASCHINEN, HERSTELLUNG, HANDEL**

**EINSTUFIGE KOMPRESSOREN**

**ZWEISTUFIGE KOMPRESSOREN**

**INDUSTRIELLE KOLBENKOMPRESSOREN**

**KOLBEN-DIESELMOTOR-KOMPRESSOREN**

**LEISE KOLBENKOMPRESSOREN**

**SCHRAUBENKOMPRESSOREN**

**DRUCKLUFTBEHÄLTER**

**LUFTTROCKNER UND FILTER**

**HOCHDRUCKREINIGER - HEISS - KALT**

**HOCHDRUCKREINIGER - KALT**













**ATK 20/100-2**



**ATK 30/300-4**

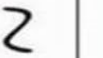

**ATK 30/200-3**

Code															
	Stationary	Lt/min	CFM	m <sup>3</sup> /h	Kw	Hp	Pump	Cylinder	RPM	Voltage	Faz	Bar	PSI	X x Y x Z mm	Kg
ATK 20/100-2	100	262	9,27	15,72	1,5	2	2800	2	1272	400	3	9	130	1150x510x940	69
ATK 20/100-2M	100	262	9,27	15,72	1,5	2M	2800	2	1272	230	1	9	130	1150x510x940	69
ATK 20/150-2	150	270	9,56	16,2	1,5	2	2800	2	1272	400	3	9	130	1350x510x940	73
ATK 20/150-2M	150	270	9,56	16,2	1,5	2M	2800	2	1272	230	1	9	130	1350x510x940	73
ATK 30/200-3	200	373	13,20	22,38	2,2	3	3900	2	1272	400	3	9	130	1370x610x1030	105
ATK 30/200-2M	200	336	11,89	20,16	1,5	2M	3900	2	1272	230	1	9	130	1370x610x1030	105
ATK 30/300-4	300	485	17,17	29,1	3	4	3900	2	1322	400	3	9	130	1680x500x1010	170
ATK 30/300-4MP	300	485	17,17	29,1	3	4M	3900	2	1322	230	1	9	130	1680x500x1010	170
ATK 30/300-5,5P	300	500	17,70	30	4	5,5	3900	2	1322	400	3	9	130	1680x500x1010	175
ATK 2X30/400-2X4P	400	970	34,34	58,2	2x3	2x4	2x3900	4	1322	400	3	9	130	1680x680x1300	225
ATK 2X30/400-2X4MP	400	970	34,34	58,2	2x3	2x4M	2x3900	4	1322	230	1	9	130	1680x680x1300	225
ATK 2X30/500-2X4P	500	970	34,34	58,2	2x3	2x4	2x3900	4	1322	400	3	9	130	2100x700x1350	265
ATK 2X30/500-2X4MP	500	970	34,34	58,2	2x3	2x4M	2x3900	4	1322	230	1	9	130	2100x700x1350	265











**100-150-200 Litre depo hacimli kompresörlerimiz tekerleklidir. Compressors which have 100 - 150 - 200 liter tank storage are wheeled.**

**AÇK 50/500-5,5 P**



**AÇK 70/500-15 YP**



Code															
	Stationary	Lt/min	CFM	m <sup>3</sup> /h	Kw	Hp	Pump	Cylinder	RPM	Voltage	Faz	Bar	PSI	X x Y x Z mm	Kg
AÇK 40/200-4	200	514	18,20	30,84	3	4	4900	2	1425	400	3	12	159	1330x610x1060	112
AÇK 40/200-4MP	200	514	18,20	30,84	3	4M	4900	2	1425	230	1	12	159	1330x610x1060	112
AÇK 40/200-5,5P	200	520	18,41	31,2	4	5,5	4900	2	1425	400	3	12	159	1330x610x1060	112
AÇK 40/300-4	300	514	18,20	30,84	3	4	4900	2	1425	400	3	12	159	1680x500x1030	165
AÇK 40/300-5,5P	300	520	18,41	31,2	4	5,5	4900	2	1425	400	3	12	159	1680x500x1030	170
AÇK 40/300-4MP	300	514	18,20	30,84	3	4	4900	2	1425	230	1	12	159	1680x500x1030	165
AÇK 40/400-4	400	514	18,20	30,84	3	4	4900	2	1425	400	3	12	159	1650x650x1250	210
AÇK 40/400-4MP	400	514	18,20	30,84	3	4	4900	2	1425	230	1	12	159	1650x650x1250	210
AÇK 40/400-5,5P	400	520	18,41	31,2	4	5,5	4900	2	1425	400	3	12	159	1650x650x1250	215
AÇK 50/500-5,5P	500	653	23,12	39,18	4	5,5	5900	2	1160	400	3	12	159	1950x650x1250	230
AÇK 50/500-7,5P	500	700	24,78	42	5,5	7,5	5900	2	1160	400	3	12	159	1950x650x1250	230
AÇK 60/500-7,5P	500	827	29,28	49,62	5,5	7,5	6000	2	1325	400	3	12	159	1950x650x1250	235
AÇK 60/500-10P	500	860	30,44	51,6	7,5	10	6000	2	1325	400	3	12	159	1950x650x1250	235
AÇK 70/500-10P	500	1210	42,83	72,6	7,5	10	7000	2	1160	400	3	12	159	1950x650x1300	250
AÇK 70/500-15YP	500	1410	49,91	84,6	11	15	7000	2	1300	400	3	12	159	1950x650x1300	260
AÇK 2x50/750-2x5,5P	750	1306	46,23	78,36	2x4	2x5,5	2x5900	4	1160	400	3	12	159	2700x650x1300	420
AÇK 2x60/750-2x7,5P	750	1654	58,55	99,24	2x5,5	2x7,5	2x6000	4	1325	400	3	12	159	2700x650x1300	440

**200 Litre depo hacimli kompresörlerimiz tekerleklidir.**







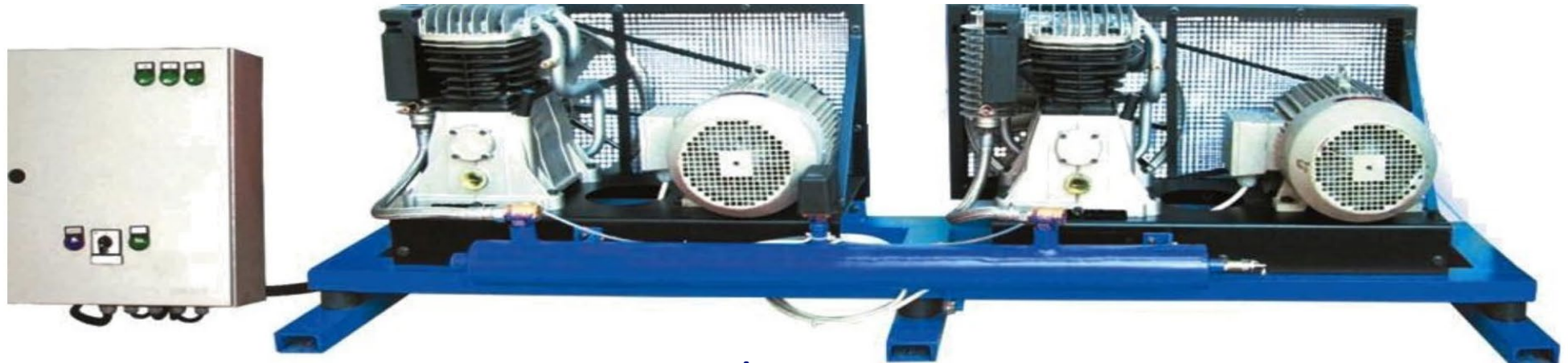



**Compressors which have 200 liter tank storage are wheeled.**



AÇK 70/15 YP ASİLKOM INDUSTRIELLE KOLBENKOMPRESSOREN













AÇK 2x60/2x7.5 P ASİLKOM INDUSTRIELLE KOLBENKOMPRESSOREN

Code															
	Stationary	Lt/min	CFM	m <sup>3</sup> /h	Kw	Hp	Pump	Cylinder	RPM	Voltage	Faz	Bar	PSI	X x Y x Z mm	Kg
AÇK 50/5,5P	500	653	23,14	39,19	5	5,5	5900	2	1160	400	3	12	159	900x560x500	115
AÇK 60/7,5P	500	827	29,30	49,64	5,5	7,5	6000	2	1325	400	3	12	159	1000x600x530	145
AÇK 60/10P	500	860	30,47	51,62	7,5	10	6000	2	1325	400	3	12	159	1000x600x530	145
AÇK 70/10P	500	1210	42,87	72,63	7,5	10	7000	2	1160	400	3	12	159	1000x750x600	155
AÇK 70/10P	1000	1210	42,87	72,63	7,5	10	7000	2	1160	400	3	12	159	1000x750x600	155
AÇK 2x60/2x7,5P	1000	1654	58,5516	99,24	2x5,5	2x7,5	2x6000	4	1325	400	3	12	159	2500x600x530	310
AÇK 2x70/2x10P	1000	2420	85,74	145,26	2x7,5	2x10	2x7000	4	1300	400	3	12	159	2650x750x600	340



**ADK 40/200-6 DİZEL**



Code												
	Stationary	Lt/min	CFM	m <sup>3</sup> /h	Hp	Pump	Cylinder	RPM	Bar	PSI	X x Y x Z mm	Kg
ADK 40/150-DİZ	150	514	18,20	30,84	5	4900	2	1285	12	159	1200x530x1100	135
ADK 40/200-DİZ	200	520	18,41	31,2	6	4900	2	1285	12	159	1330x630x1160	145
ADK 50/300-DİZ	300	653	23,12	39,18	7,2	5900	2	1160	12	159	1700x550x1200	165
ADK 60/500-DİZ	500	860	30,44	51,6	10,5	6000	2	1325	12	159	1950x650x1350	230
ADK 70/500-DİZ	500	1210	42,83	72,60	10,5	7000	2	1160	12	159	1700x800x1400	235

**150 - 200 Litre depo hacimli kompresörlerimiz tekerleklidir.**

**Compressors which have 150 - 200 liter tank storage are wheeled.**

**Pistonlu dizel kompresörlerimiz akümülatör ile çalışabilecek düzenekte olup, akümülatör içermez.**



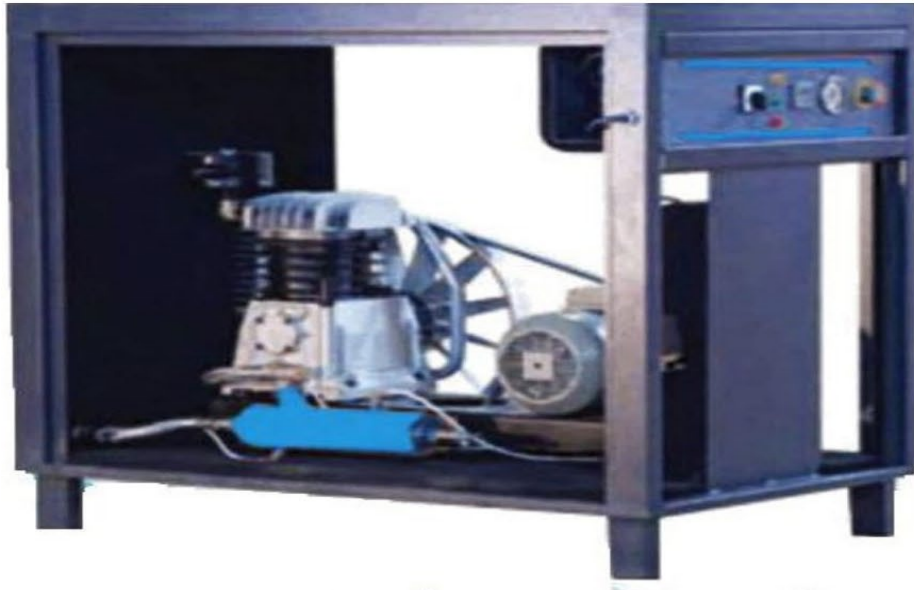





**Piston compressor which has diesel engine is provided working with accumulator, but does not include battery.**



SIL 30/3 LEISE KOLBENKOMPRESSOR



SIL 50/5,5 LEISE KOLBENKOMPRESSOR

Code													
	Stationary	Lt/min	CFM	m <sup>3</sup> /h	Kw	Hp	Pump	Cylinder	Db (a)	Bar	PSI	X x Y x Z mm	Kg
SILENT 20/2M	100	262	9,2748	15,72	1,5	2M	2800	2	64	9	130	1000x600x880	145
SILENT 30/3	200	373	13,2042	22,38	2,2	3	3900	2	64	9	130	1000x600x880	145
SILENT 30/4	300	485	17,169	29,1	3	4	3900	2	64	9	130	1000x600x880	155
SILENT 40/5,5	300	520	18,408	31,2	4	5,5	4900	2	65	12	159	1000x600x880	160
SILENT 50/5,5	500	653	23,1162	39,18	4	5,5	5900	2	68	12	159	110x700x1000	170
SILENT 60/7,5	500	827	29,2758	49,62	5,5	7,5	6000	2	68	12	159	110x700x1000	175
SILENT 70/10	500	1210	42,834	72,6	7,5	10	7000	2	68	12	159	110x700x1000	200

AVK 50 SCHRAUBENKOMPRESSOREN



AVK 30 SCHRAUBENKOMPRESSOREN









AVK 20 SCHRAUBENKOMPRESSOREN

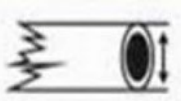

AVK 15 TANK-TOP-SCHRAUBENKOMPRESSOREN



Code	 								
	7,5 BAR Lt/min	10 BAR Lt/min	13 BAR Lt/min	Kw	Hp	R"	Db(a)	X x Y x Z mm	Kg
AVK 7,5-500 Lt.Tank Üstü	900	700	600	5,5	7,5	3/4"	65	1950x600x1430	370
AVK 10-500 Lt.Tank Üstü	1050	950	850	7,5	10	3/4"	65	9500x600x1430	380
AVK 15-500 Lt.Tank Üstü	1900	1600	1250	11	15	3/4"	68	1950x700x1500	390
AVK 15	1900	1600	1250	11	15	3/4"	68	750X800X1210	650
AVK 20	2600	2100	1600	15	20	1"	70	850X1000X1400	700
AVK 25	3450	2850	2150	18	25	1"	71	850X1000X1400	725
AVK 30	3800	3300	2900	22	30	1 1/4"	71	850X1000X1400	750
AVK 40	5300	4400	3600	30	40	1 1/4"	72	1000X1000X1500	850
AVK 50	6300	5400	4400	37	50	1 1/2"	75	1000X1000X1500	875
AVK 60	7500	6500	5600	45	60	2"	75	1300X1300X1500	900
AVK 75	9600	8500	6900	55	75	2"	77	1300X1300X1500	925
AVK 100	13100	11000	9200	75	100	2"	77	1350X1600X1500	1450
AVK 125	16200	14000	12000	90	125	3"	78	2350X200X1700	1600
AVK 150	20000	17000	14500	110	150	3"	78	2350X200X1700	1850
AVK 180	23400	19500	17000	132	180	3"	78	2500X2000X1700	2100
AVK 220	27500	23700	19800	160	220	3"	78	2800X2000X1700	3000
AVK 270	36700	30900	25200	200	270	3"	79	3000X2000X1700	3500
AVK 340	44500	38000	32000	250	340	3"	79	3000X2000X1700	3500

*The screw output values are determined by the atmospheric pressure of 1 bar, the relative humidity is 0% and 20 ° C ambient temperature according to standard values.*

# ASİLKOM DRUCKLUFTBEHÄLTER



*100 Lt.*



*300 Lt.*

*500 Lt.*

*1000 Lt.*

*2000 Lt.*

*5000 Lt.*

Code					
	Stationary	A (mm)	B (mm)	C (mm)	Kg
100 LT/DİK TANK	100	323	1150	1600	55
200 LT/DİK TANK	200	400	1500	1950	85
300 LT/DİK TANK	300	550	1200	1760	95
500 LT/DİK TANK	500	600	1500	2090	180
1000 LT/DİK TANK	1000	850	1500	2220	320
2000 LT/DİK TANK	2000	1150	1500	2340	650
3000 LT/DİK TANK	3000	1400	1500	2480	800
5000 LT/DİK TANK	5000	1600	2000	3100	1860

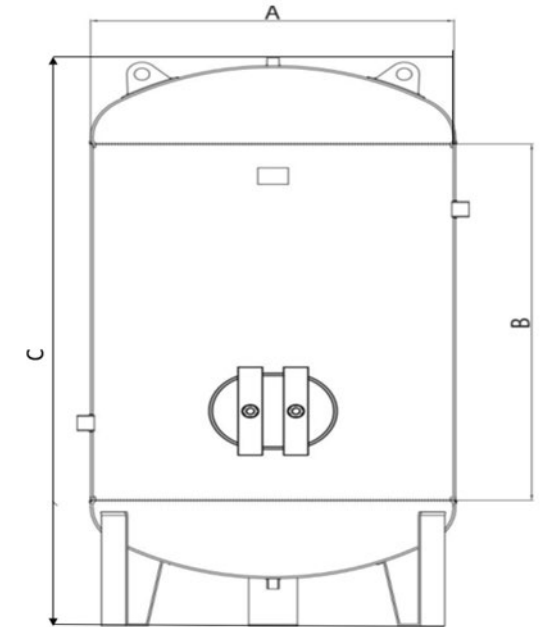

AHK- 160.000

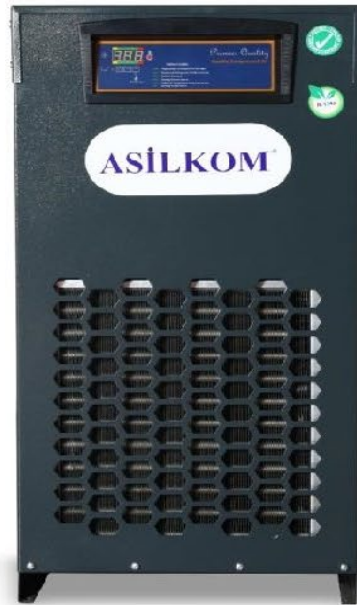

AHK- 80.000

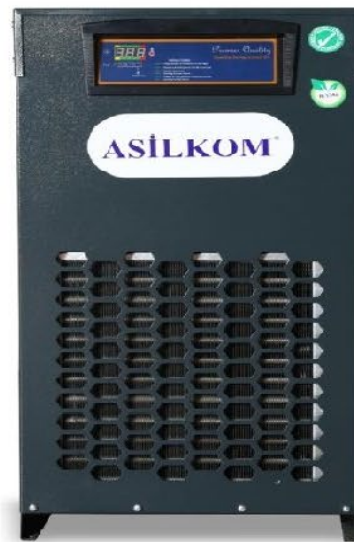

AHK- 17.000



AHK- 6500





Modell	Kapazität Nm/dk(min)	Verbindungsgröße	Elektrisch ( Voltage V/ph/Hz)
AHK 900	0.9	1/2	230/1/50
AHK 1200	1.2	1/2	230/1/50
AHK 1800	1.8	3/4	230/1/50
AHK 2200	2.2	3/4	230/1/50
AHK 2600	2.6	1	230/1/50
AHK 3100	3.1	1	230/1/50
AHK 3700	3.7	1	230/1/50
AHK 4500	4.5	1	230/1/50
AHK 5500	5.5	1	230/1/50
AHK 6500	6.5	1 1/2	230/1/50
AHK 8500	8.5	1 1/2	230/1/50
AHK 11000	11	2	400/3/50
AHK 13000	13	2	400/3/50
AHK 17000	17	2	400/3/50
AHK 20000	20	2	400/3/50
AHK 25000	25	2	400/3/50
AHK 30.000	30	3	400/3/50
AHK 35.000	35	3	400/3/50
AHK 40.000	40	3	400/3/50
AHK 45.000	45	3	400/3/50
AHK 50.000	50	3	400/3/50
AHK 60.000	60	DN 100	400/3/50
AHK 70.000	70	DN 100	400/3/50
AHK 80.000	80	DN 100	400/3/50
AHK 90.000	90	DN 100	400/3/50
AHK 105.000	105	DN 150	400/3/50
AHK 120.000	120	DN 150	400/3/50
AHK 140.000	140	DN 150	400/3/50
AHK 160.000	160	DN 200	400/3/50

Modell	Kapazität Nm <sup>3</sup> /min	Verbindungsgröße
AAKK- 250	0,25	1/2"
AAKK - 500	0,5	1/2"
AAKK -800	0,8	1/2"
AAKK - 1200	1,2	1/2"
AAKK - 1800	1,8	3/4"
AAKK - 2600	2,6	1"
AAKK - 3700	3,7	1"
AAKK - 5500	5,5	1 1/4"
AAKK - 7000	7	1 1/2"
AAKK - 8500	8,5	2"
AAKK - 11.000	11	2"
AAKK - 16.000	16	2"
AAKK - 22.000	22	2"
AAKK - 24.000	24	2 1/2"
AAKK - 30.000	30	3"
AAKK - 45.000	45	3"
AAKK - 60.000	60	DN 100
AAKK - 71.000	71	DN 100
AAKK - 90.000	90	DN 150
AAKK - 120.000	120	DN 150
AAKK - 140.000	140	DN 150
AAKK - 180.000	180	DN 200

AAKK - 180.000



AAKK - 60.000



AAKK - 7000



AAKK - 3700



Modell	Kapazität Nm <sup>3</sup> /min	Verbindungsgröße	Elektrisch ( Voltage V/ph/Hz)
AKK 900	0.9	1/2	230/1/50
AKK 1200	1.2	1/2	230/1/50
AKK 1800	1.8	3/4	230/1/50
AKK 2200	2.2	3/4	230/1/50
AKK 2600	2.6	1	230/1/50
AKK 3100	3.1	1	230/1/50
AKK 3700	3.7	1 1/2	230/1/50
AKK 4500	4.5	1 1/2	230/1/50
AKK 5500	5.5	1 1/2	230/1/50
AKK 6500	6.5	1 1/2	230/1/50
AKK 8500	8.5	1 1/2	230/1/50
AKK 11000	11	2	400/3/50
AKK 13000	13	2	400/3/50
AKK 17000	17	2	400/3/50
AKK 20000	20	2	400/3/50
AKK 25000	25	2	400/3/50
AKK 30.000	30	3	400/3/50
AKK 35.000	35	3	400/3/50
AKK 40.000	40	3	400/3/50
AKK 45.000	45	3	400/3/50
AKK 50.000	50	3	400/3/50
AKK 60.000	60	DN 100	400/3/50
AKK 70.000	70	DN 100	400/3/50
AKK 80.000	80	DN 125	400/3/50
AKK 90.000	90	DN 125	400/3/50
AKK 105.000	105	DN 150	400/3/50
AKK 120.000	120	DN 150	400/3/50
AKK 140.000	140	DN 200	400/3/50
AKK 160.000	160	DN 200	400/3/50

